

BL30-3P



SUCTION CUP SPECIALLY DESIGNED FOR PLASTIC BAG HANDLING

- ▶ High-flow fitting allowing high initial vacuum flow needed for plastic bag handling.
- ▶ Suitable for level adjustment and uneven surfaces.
- ▶ Dual hardness allowing strength and stability in conjunction with softness and flexibility.
- ▶ DURAFLEX® material features the elasticity of rubber in combination with the wear resistance of polyurethane.
- ▶ The DURAFLEX® material is mark-free.

LIFTING FORCES & TECHNICAL DATA

Lifting force vertical to the surface, N, at vacuum level			Lifting force parallel to the surface, N, at vacuum level			Volume cm ³	Min. curve radius mm	Max. vertical movement mm	Weight rubber part g
20 -kPa	60 -kPa	90 -kPa	20 -kPa	60 -kPa	90 -kPa				
10	22	28	9*	10*	16*	14	6	14	6

*The suction cup is not intended for handling shear lifts. The values are given as a dimensioning guide to be used when, e.g., the acceleration/retardation causes shear forces.

MATERIAL SPECIFICATIONS

Material	Colour	Hardness °Shore A	Temperature range °C
Polyurethane, PU30	Yellow	30	10–50
Polyurethane, PU70	Black	70	10–50

MATERIAL RESISTANCE

Wear resistance	Oil	Weather & ozone	Hydrolysis	Petrol	Concentrated acids	Ethanol	Methanol	Oxidation
Excellent	Excellent	Excellent	Fair**	Fair	Fair**	Fair	Poor	Poor

**Please contact PIAB.

ORDERING INFORMATION

Complete suction cup		Art. No.
A	Suction cup BL30-3P Polyurethane 30/70, G3/8" male	0113743
B	Suction cup BL30-3P Polyurethane 30/70, 3/8" NPT male	0113744

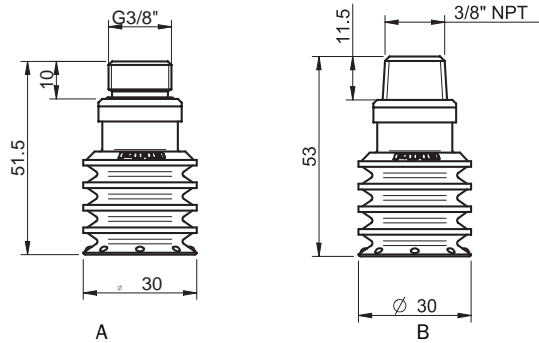

Rubber part		Art. No.
Suction cup BL30-3P Polyurethane 30/70		0110545

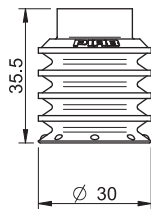

Fitting		Art. No.
Fitting G3/8" male, bag		0112662
Fitting 3/8" NPT male, bag		0112692

Suction cups
BL-P